

 breezefree

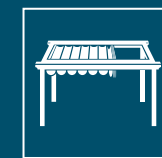

Pergolas

Contents

Introduction.....	3
Sizes.....	4
Support & Fixing.....	5
Wall Fixed.....	5
Front Stanchions.....	6
Upper Cantilever.....	7
Lower Fixed.....	8
Free Standing.....	9
Butterfly.....	10
Track Styles.....	11
Flat.....	11
Inclined.....	12
Curved.....	13
Vaulted.....	14
Enclosures.....	15
Screens.....	16
Fabric Membranes.....	17
Canopy Colours.....	18
Frame Finishes.....	19
Branding.....	20
Gutters.....	21
Heating.....	22
Lighting.....	23
Sun, Wind & Rain Sensors.....	24

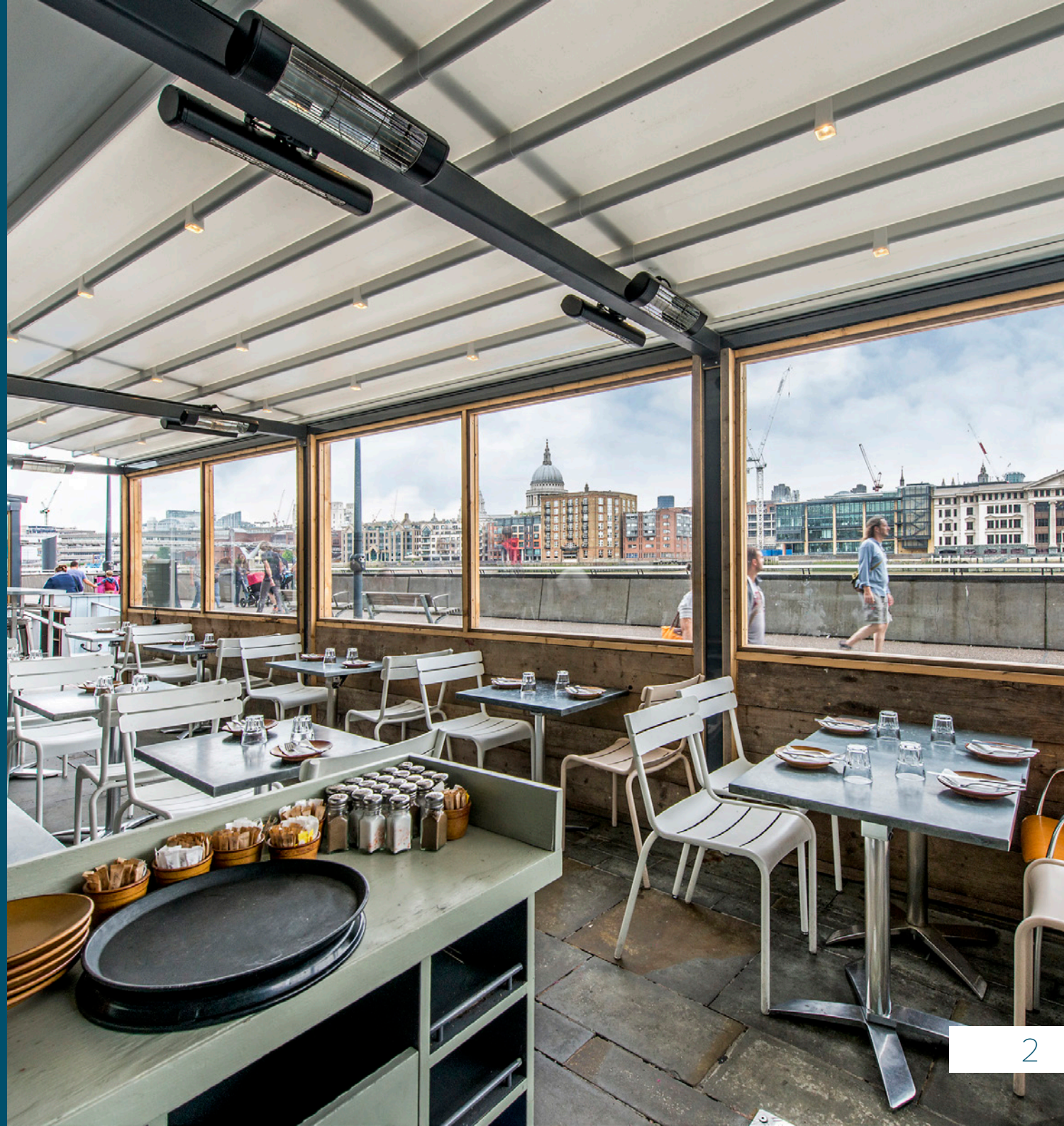

Introduction

Pergola Awnings are supported, retractable roofs that generally project from a building. Providing fully adjustable shade and shelter over a wide area, they make the perfect choice for larger terrace spaces. Constructed from durable materials and with minimal maintenance required, they are effectively an alternative to building an extension.

- Particularly well suited to covering large areas
- Metal pergola (steel, aluminium) or wooden pergola options available in a wide range of colours
- Motorised adjustment of shade and shelter
- Wall supported or free standing





Sizes

Pergola Awnings come in a wide range of sizes and can be used for anything from a small pub terrace to a large outdoor function space.

Our project management team can advise on the best way to cover your alfresco area.

One Module

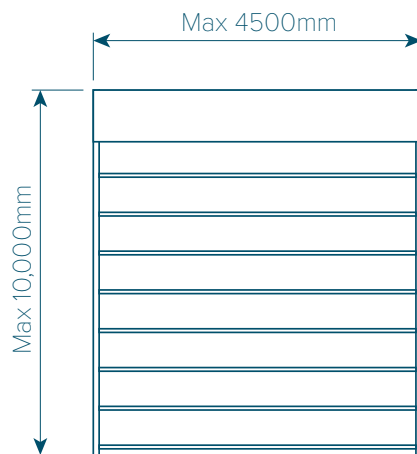

Two Modules

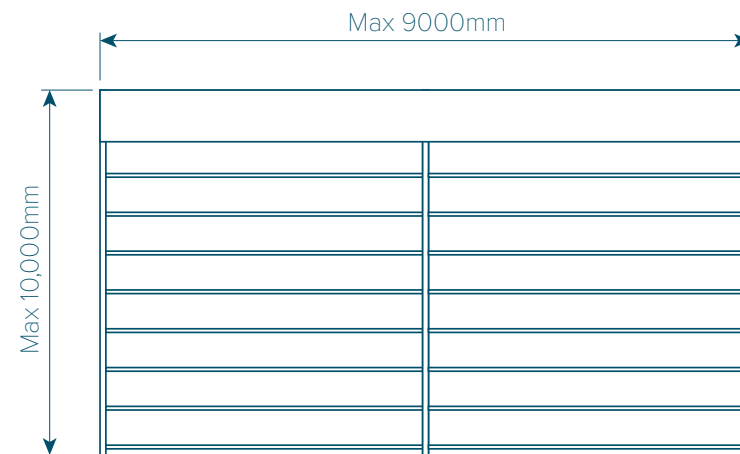

Three Modules

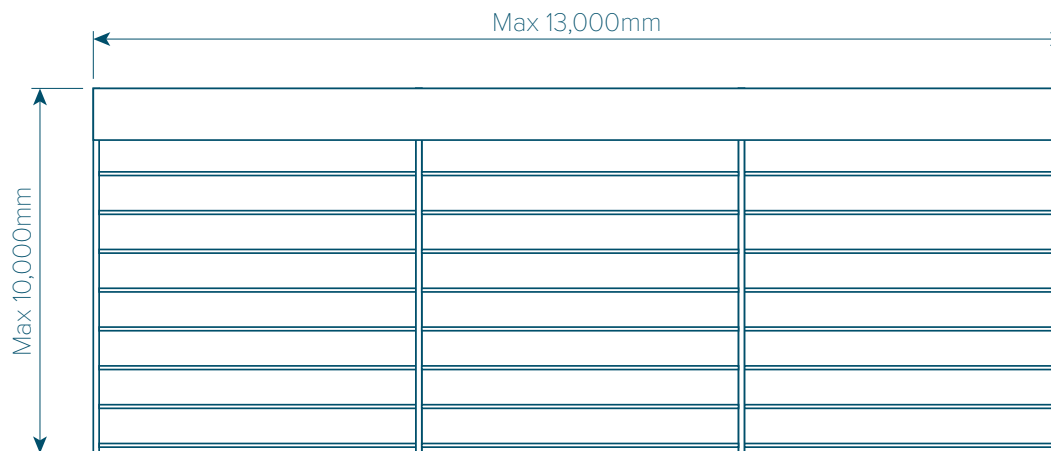

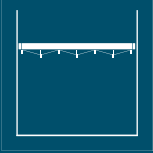

Support & Fixing

Wall Fixed

Fixing to walls or other surrounding structures where possible can help reduce the cost of a pergola awning, as well as maximising potential space.

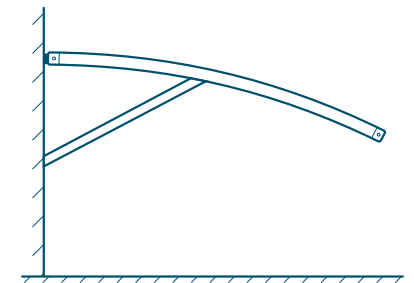
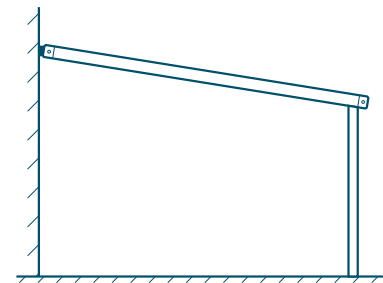

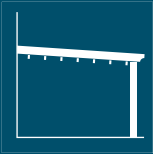

Support & Fixing

Front Supports

This “Lean To” style is the most popular Pergola awning configuration, providing coverage around doorways and extending out over patios.

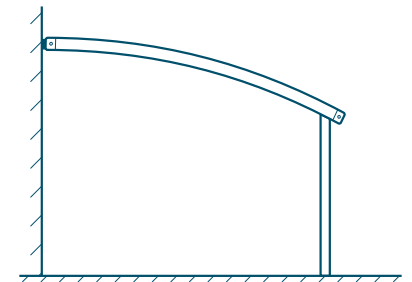
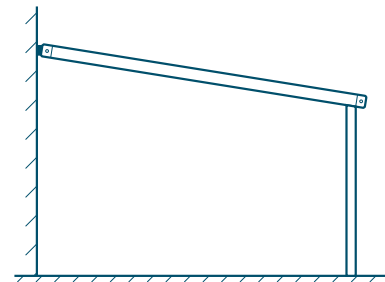
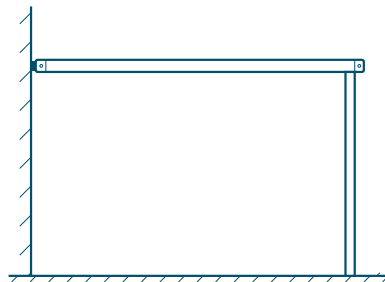

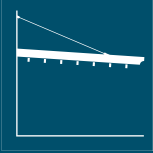

Support & Fixing

Upper Cantilever

When the height of a building or structure will allow, an upper-cantilevered fixing ensures great coverage without front supports causing potential obstructions.

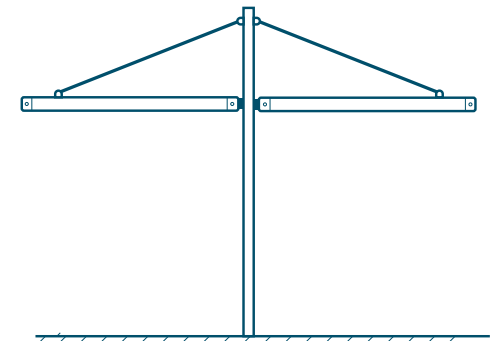
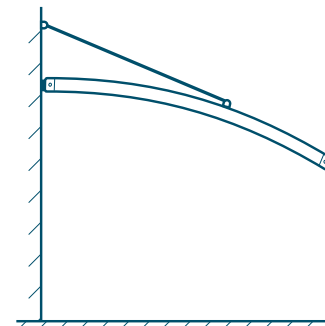
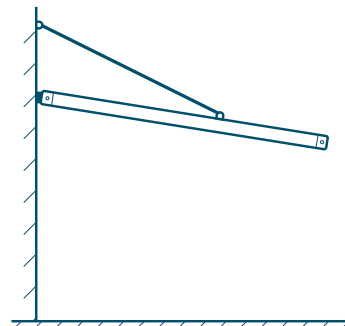

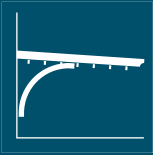

Support & Fixing

Lower Cantilever

Lower cantilever fixings eliminate the need for front supports and can make for eye-catching design features.

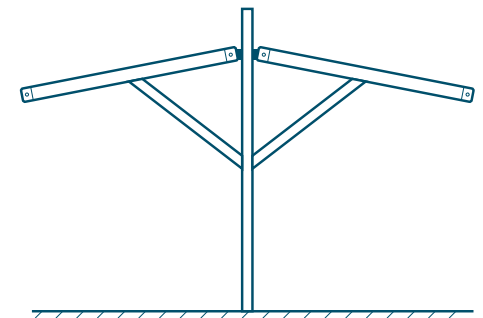
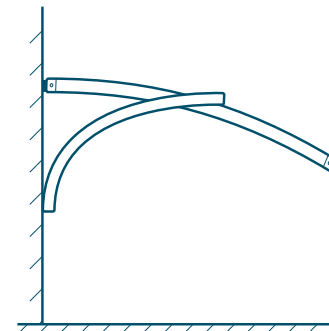
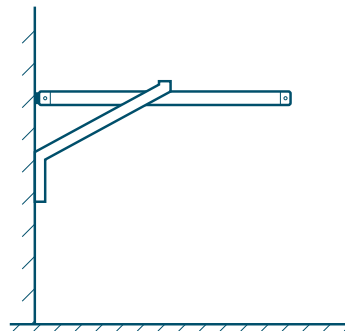



Support & Fixing

Free-Standing

When there is no suitable building or structure to fix to, Pergola Awnings can be completely free-standing.

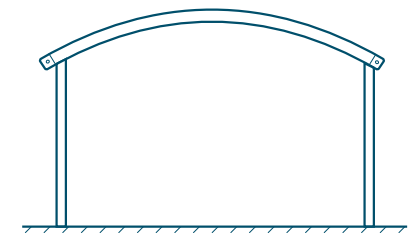
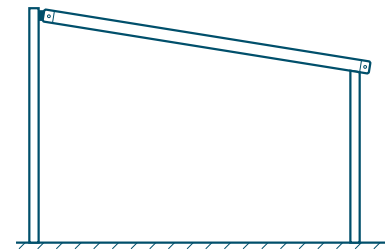



Support & Fixing

Butterfly

A simple “goalpost” structure fixed into the ground can be used to support two Pergola Awnings back-to-back.

This maximises the amount of coverage possible - up to 20 metres!



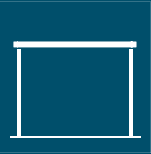

Track Styles

Flat

Using alternately pitched rails, Pergola Awnings can be totally flat and still allow water to run off the roof.

Alternatively, a “side-inclined” Pergola Awning can be given a very slight pitch.



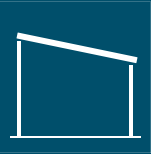

Track Styles

Inclined

The most common style of Pergola
Awning is pitched at 12-15° to allow water
to run off the closed roof.





Track Styles

Curved

A variation on the traditional inclined roof allows for an eye-catching curved design.





Track Styles

Vaulted

Vaulted, or arched, Pergola Awning roofs make for a dramatic design statement and are particularly impressive from inside.





Enclosure

All our Pergola Awnings can be turned into dynamic outdoor rooms with the addition of side enclosure options. This could take the form of fixed glass, sliding/bi-fold doors or pull-down-vertical blinds and windows.





Screens

An alfresco area covered by a Pergola Awning can be further defined with the addition of Breezefree's SmartScreens and Café Screens. These can be standalone or integrated into the surrounding structure, providing additional shelter and opportunities for branding.





Fabric Membranes

World-renowned **Ferrari** and **Mehler** fabrics are used in our Pergola Awnings to ensure premium quality, durability and water-resistance.





Canopy Colours

A wide range of fabric colours are available to complement any alfresco scheme or create a new style or mood.

Ferrari Precontrait 302



Bianco



Avorio



Beige 1



Beige 2



Giallo 1



Giallo 2



Salmone



Rosso



Marron



Menta



Verde Medio



Verde Scuro



Caraibi



Blu



Ghiaccio



Grigio



Argento



Frame Finishes

RAL

All metalwork can be powder-coated with a vast range of RAL finishes. Consult a RAL swatch book or contact Breezefree for more information

Wood Stains

Wooden Pergola Awning structures can be stained or painted with any finish suitable for outdoor use.

Textured Coatings

Metal structures can be finished with special textured coatings for a truly unique look.

Metal Frame Finishes



Corten



RAL 9010



RAL 9006



Iron Grey

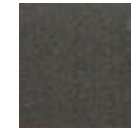

RAL 8017

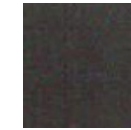

Bronze

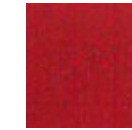

RAL 3003



RAL 5010



RAL 6005

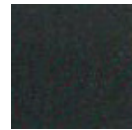

RAL 7016



RAL 9007



RAL 1013



Metallic Black



Old Grey

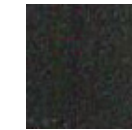

Old Brown

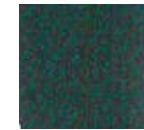

Old Green

Wooden Frame Finishes



Dark Green



Sage Green



Mahogany

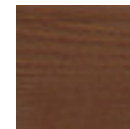

Walnut



Antique



Pewter

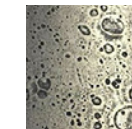

Bronze

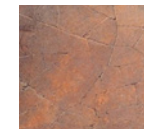

Corten

Textured Coatings





Branding

While the outside of the Pergola Awning roof often goes unseen, the underside is right above your customers' heads and is, therefore, a perfect location to display your establishment's identity or advertise a particular brand.





Gutters

All our Pergola Awnings can be constructed with integrated or bespoke guttering to ensure your alfresco area remains dry.





Heating

The frame of a Pergola Awning is a perfect place to mount electric, infrared heaters to keep your customers warm and extend the use of your alfresco area into the cooler months.

If your Pergola Awning is fully enclosed, why not employ some lightless, ceramic heaters? These efficient heaters work best in draft-free environments and eliminate the orange glare of traditional heaters, allowing you to control the lighting more effectively.





Lighting

The cross-beams of our Pergola Awnings can be fitted with LED lighting to efficiently illuminate an alfresco area in the evening. The surrounding structure can also be fitted with up and down lighting for even more possibilities.





Sun, Wind & Rain Sensors

Weather sensors can be fitted to our Pergola Awnings to ensure roofs extend at the first sign of rain to automatically protect your patrons, or retract to protect themselves from damage during particularly strong winds.





Unit 7 Mitcham Industrial Estate
Streatham Road
Mitcham
CR4 2AP

020 8877 3030 • breezefree.com